

FOCUS ON PEOPLE
#STAYSAFE

CONDIZIONI GENERALI

ORDINE MINIMO: € 300,00 netti
ORDINI FRA I €300,00 E I 1.500,00 NETTI: € 70,00 di contributo spese
ORDINI SUPERIORI A € 1.500,00 NETTI: porto franco
TEMPI DI CONSEGNA: entro 5 settimane dall'attivazione dell'ordine
I.V.A.: esclusa
Per ordini eccezionalmente accettati sotto € 300,00, spese di gestione € 20,00.

VALIDITÀ: **31.12.2020**

GENERAL CONDITION

MINIMUM ORDER: € 300,00 net
ORDERS NET FROM € 300,00 TO € 1.500,00: € 70,00 shipping expenses
ORDERS NET ABOVE € 1.500,00: without any shipping expenses
LEAD TIME: within 5 weeks from order activation
T.V.A.: not included
For orders exceptionally accepted under € 300,00, management fees € 20,00.

PRICELIST VALIDITY: **31.12.2020**

CONDITIONS GÉNÉRALES

MINIMUM DE COMMANDE: € 300,00 net
COMMANDES NETS DE € 300,00 JUSQU'À € 1.500,00: € 70,00 frais de transport
COMMANDES NETS DE PLUS DE € 1.500,00: franco votre usine
DELAIS DE LIVRAISON: dans 5 semaines après l'activation de la commande
H.T.: exclue
Pour commandes exceptionnellement acceptées sous € 300,00, frais de gestion € 20,00.

VALIDITÉ DE TARIF: **31.12.2020**

ALLGEMEINE BEDINGUNGEN

MINDBESTELLWERT € 300,00 net
LIEFERWERT NETTO VON € 300,00 BIS € 1.500,00: € 70,00 Spesenbetrag
LIEFERWERT NETTO ÜBER € 1.500,00: Frei haus
LIEFERZEIT: Innerhalb 5 Wochen ab Aktivierung von Bestellung
MWST: Ausgeschlossen
Für Bestellungen außergewöhnlich unter € 300,00 akzeptiert, Betriebs kostet € 20,00.

GÜLTIGKEIT FÜR PREISLISTE: **31.12.2020**

CONDICIONES GENERALES

PEDIDO MINIMO: € 300,00 netos
ORDENES NETOS DESDE € 300,00 HASTA € 1.500,00: € 70,00 de gastos de transporte
ORDENES NETOS SUPERIORES A € 1.500,00: entrega sin pago del transporte
TIEMPO DE ENTREGA: dentro de 5 semanas de activación de orden
IVA: no incluida
Por ordenes excepcionalmente aceptados debajo € 300,00, € 20,00 gestión.

VALIDEZ DE TARIFAS: **31.12.2020**



NOME:
PLEXDESK

IT

DESCRIZIONE:
Pannello in acrilico estruso

APPLICAZIONI:

- Scrivania con staffe
- Scrivania con staffe SLALOM
- Autoportante sistema SLALOM

DIMENSIONI:
L 60 | 80 | 100 | 120 | 140 | 160 x
H 60 x SP 0,1 | 0,4 | 0,6 cm
L 23,6 | 31,5 | 39,4 | 47,2 | 55,1 | 63 x
H 23,6 in x SP 0,1 | 0,4 | 0,6 cm
Forme e dimensioni su richiesta

SPESSORE:

- 10/10 (1mm)
- 40/10 (4mm)
- 60/10 (6mm)

MANUTENZIONE:

- SLALOM PLEXDESK assorbe l'umidità durante lo stoccaggio e l'applicazione. Oltre alla variazione lineare termica, il contenuto di umidità può influire su una variazione dimensionale aggiuntiva fino allo 0,5%.

- SLALOM PLEXDESK è soggetto a variazioni lineari a temperature variabili. Le materie plastiche mostrano un cambiamento lineare più elevato rispetto ai metalli e questo deve essere preso in considerazione quando si montano i pannelli nei telai.

- SLALOM PLEXDESK mostra un coefficiente di dilatazione termica lineare di 0,07 mm / m • ° C.

Quando si montano i pannelli PLEXDESK, è necessario prestare attenzione ai margini di allungamento per evitare danni durante l'utilizzo del materiale.

**CONFORMITÀ STANDARD
PRODOTTO:**
EN ISO 7823-2

NAME:
PLEXDESK

EN

DESCRIPTION:
Extruded Acrylic sheets

APPLICATIONS:

- Desk with brackets
- Desk with SLALOM brackets
- SLALOM freestanding system

DIMENSIONS:
L 60 | 80 | 100 | 120 | 140 | 160 x
H 60 x SP 0,1 | 0,4 | 0,6 cm
L 23,6 | 31,5 | 39,4 | 47,2 | 55,1 | 63 x
H 23,6 in x SP 0,1 | 0,4 | 0,6 cm
Shapes and sizes on request

THICKNESS:

- 10/10 (1mm)
- 40/10 (4mm)
- 60/10 (6mm)

MAINTENANCE:

- SLALOM PLEXDESK absorbs moisture during storage and application. Beyond the thermal linear change, the content of moisture can affect an additional dimensional change up to 0.5%.

- SLALOM PLEXDESK is subject to linear change at variable temperatures. Plastics show higher linear change than metals, and this must be taken into account when mounting sheets into frames.

- SLALOM PLEXDESK shows a coefficient of linear thermal expansion of 0,07 mm/m • °C.

When mounting PLEXDESK sheets, attention must be paid to the elongation clearances in order to avoid damage during material usage.

**STANDARD PRODUCT
COMPLIANCE:**
EN ISO 7823-2

DENOMINATION:
PLEXDESK

FR

DESCRIPTION:
Feuilles acryliques extrudées

APPLICATION:

- Bureau avec supports
- Bureau avec supports SLALOM
- Système autoportant SLALOM

DIMENSIONS:
L 60 | 80 | 100 | 120 | 140 | 160 x
H 60 x SP 0,1 | 0,4 | 0,6 cm
L 23,6 | 31,5 | 39,4 | 47,2 | 55,1 | 63 x
H 23,6 in x SP 0,1 | 0,4 | 0,6 cm
Formes et tailles sur demande

EPAISSEUR:

- 10/10 (1mm)
- 40/10 (4mm)
- 60/10 (6mm)

ENTRETIEN:

- SLALOM PLEXDESK absorbe l'humidité pendant le stockage et l'application. Au-delà du changement thermique linéaire, la teneur en humidité peut affecter un changement dimensionnel supplémentaire jusqu'à 0,5%.

- SLALOM PLEXDESK est soumis à des changements linéaires à des températures variables. Les plastiques présentent un changement linéaire plus élevé que les métaux, et cela doit être pris en compte lors du montage des feuilles dans les cadres.

- SLALOM PLEXDESK montre un coefficient de linéarité dilatation thermique de 0,07 mm / m • ° C.

Lors du montage des plaques PLEXDESK, une attention particulière doit être accordée aux jeux d'allongement afin d'éviter tout dommage lors de l'utilisation du matériau.

**CONFORMITÉ DU PRODUIT
STANDARD:**
EN ISO 7823-2

Property	corresponding	Unit	Required value
Tensile strength	ISO 527-2	Mpa	≥ 60
Elongation at break	ISO 527-2	%	≥ 2
Modulus of elasticity	ISO 527-2	MPa	≥ 2900
Charpy Impact Strength (unnotched)	ISO 179-1	kJ/m ²	≥ 8
Total luminous transmittance	DIN 5036-3 / ISO 13468-1	%	≥ 90
Vicat softening temperature	DIN EN ISO 306 Method B50	°C	≥ 88
Flexural strength	ISO 178	MPa	100 to 115
Temperature of deflection under load	ISO 75-2/A	°C	80 to 101
Haze	ASTM D-1003 / ISO 14782	%	0.5 to 2



Spessore 6mm | thickness 6mm | epaisseur 6mm | Dicke 6mm | esesor 6mm
Acrilico | Acrylic



PX-SS/2
30xH15
11.81H5.9
Tr
20,00

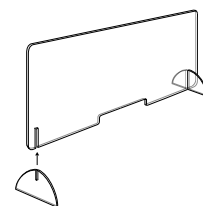



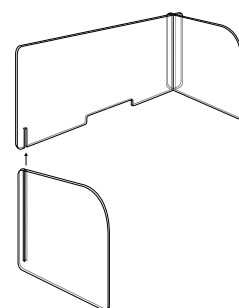



PX-SD-57.60 **PX-DD-57.60**
57xH60 57xH60
22.44xH23.6 22.44xH23.6
Tr Tr
71,00 **122,00**









PX-SD-77.60 **PX-DD-77.60**
77xH60 77xH60
30.31xH23.6 30.31xH23.6
Tr Tr
88,00 **156,00**

H 60 cm/ H 23.6 in

					
COD	PX-D1-80.60	PX-D1-100.60	PX-D1-120.60	PX-D1-140.60	PX-D1-160.60
CM	80xH60	100xH60	120xH60	140xH60	160xH60
IN	31.5xH23.6	39.4xH23.6	47.2xH23.6	55.1xH23.6	63xH23.6
CO	Tr	Tr	Tr	Tr	Tr
€	78,00	92,00	108,00	120,00	151,00

H 60 cm/ H 23.6 in

					
COD	PX-D1-80.60/F	PX-D1-100.60/F	PX-D1-120.60/F	PX-D1-140.60/F	PX-D1-160.60/F
CM	80xH60	100xH60	120xH60	140xH60	160xH60
IN	31.5xH23.6	39.4xH23.6	47.2xH23.6	55.1xH23.6	63xH23.6
CO	Tr	Tr	Tr	Tr	Tr
€	78,00	92,00	108,00	120,00	151,00



PX-SD-114.60 **PX-DD-114.60**
114xH60 114xH60
44.9xH23.6 44.9xH23.6
Tr Tr
118,00 **216,00**

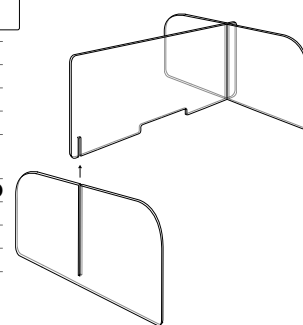

PX-SD-154.60 **PX-DD-154.60**
154xH60 154xH60
60.63xH23.6 60.63xH23.6
Tr Tr
161,00 **302,00**

Note:

Forme e dimensioni su richiesta
shapes and sizes on request
formes et tailles sur demande
Formen und Größen auf Anfrage erhältlich
formas y tamaños bajo pedido

Optional: DIS-2

Giunto per pannelli | joint for panels | joint pour panneaux en ligne
Fuge für Paneele in Linie | junta para paneles en línea



DIS-2
Ø10
Ø3.94
Tr
10,00

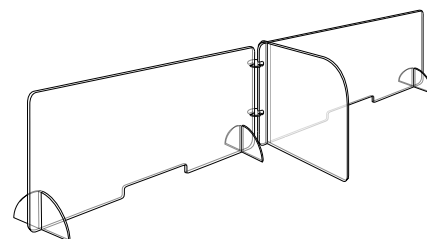



Spessore 4mm | thickness 4mm | épaisseur 4mm | Dicke 4mm | espesor 4mm
Acrilico | Acrylic

H 60 cm/ H 23.6 in

COD	PX-D2-60.60	PX-D2-80.60	PX-D2-100.60	PX-D2-120.60	PX-D2-140.60
CM	60xH60	80xH60	100xH60	120xH60	140xH60
IN	23.6xH23.6	31.5xH23.6	39.4xH23.6	47.2xH23.6	55.1xH23.6
CO	TR	TR	TR	TR	TR
€	40,00	54,00	65,00	72,00	77,00

H 60 cm/ H 23.6 in

COD	PX-D2-60.60/F	PX-D2-80.60/F	PX-D2-100.60/F	PX-D2-120.60/F	PX-D2-140.60/F
CM	60xH60	80xH60	100xH60	120xH60	140xH60
IN	23.6xH23.6	31.5xH23.6	39.4xH23.6	47.2xH23.6	55.1xH23.6
CO	TR	TR	TR	TR	TR
€	40,00	54,00	65,00	72,00	77,00

ED-SM.40/2	ED-SS.40/2	ED-SD.40/2
6x3xH27	6x3xH27	10x3xH27
2.4x1.2xH10.6	2.4x1.2xH10.6	3.9x1.2xH10.6
Bo - GR	Bo - GR	Bo - GR
79,00	60,00	62,00

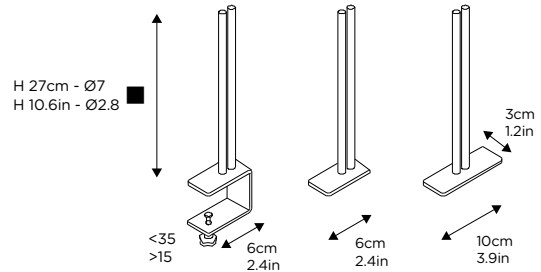

Note:

Forme e dimensioni su richiesta
shapes and sizes on request
formes et tailles sur demande
Formen und Größen auf Anfrage erhältlich
formas y tamaños bajo pedido

optional: i montanti nel colore fuori serie **NERO** (NG) sono soggetti ad un aumento del +15% sul prezzo di listino.

I montanti nei colori **RAL** sono disponibili su richiesta.

optional: special upright color **BLACK** (NG) undergo an increase of +15% on the pricelist.

The uprights in the **RAL** colours are available on request.

optional: les montants en couleur **NOIR** (NG) sont soumis à une augmentation de +15% sur le prix de liste.

Les montants dans les couleurs **RAL** sont disponibles sur demande.

optional: Farbe **SCHWARZ** (NG) verfügbar mit +15% auf Preisliste.

Die Ständer in den **RAL**-Farben sind auf Anfrage erhältlich.

optional: color por montantes **NEGRO** (NG) están sujetos a un incremento del +15% su precio de lista.

Los montantes en los colores **RAL** están disponibles a petición.

optional: distanziali | spacers | espaceurs | Abstandshalter | espaciadores

COD	ED-DIS 3
CM	3x1xH0,3
IN	1.2x0.4xH0.12
CO	Bo - GR
€	7,00

Suggerione: Potrà essere sostituito con ECODesk

suggestion: It can be replaced with ECODesk

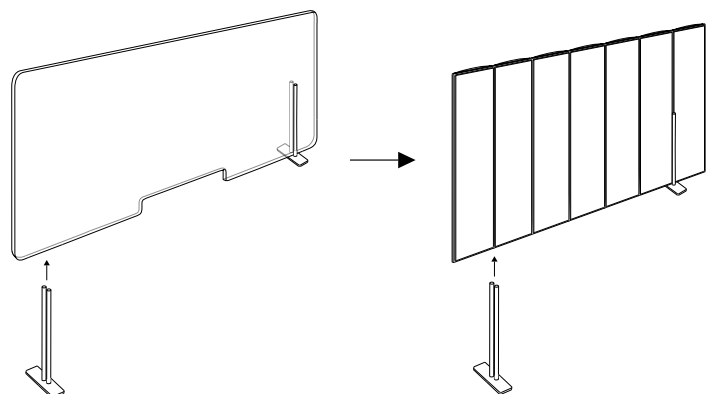



Spessore 6mm | thickness 6mm | epaisseur 6mm | Dicke 6mm | esesor 6mm
Acrilico | Acrylic

H 60 cm/ H 23.6 in



COD	PX-D1-180.60	PX-D1-240.60
CM	180xH60	240xH60
IN	70.8xH23.6	94.5xH23.6
CO	TR	TR
€	185,00	on request

H 60 cm/ H 23.6 in



COD	PX-D1-180.60/F	PX-D1-240.60/F
CM	180xH60	240xH60
IN	70.8xH23.6	94.5xH23.6
CO	TR	TR
€	185,00	on request

Note:

Forme e dimensioni su richiesta
shapes and sizes on request
formes et tailles sur demande
Formen und Größen auf Anfrage erhältlich
formas y tamaños bajo pedido



PX-CS-80.70	PX-ED-120.60	PX-S1-80.70	PX-S2-70.70	PX-S3-120.60	PX-S4-100.60
80xH70	120xH60	80xH70	70xH70	120xH60	100xH70
31.5xH27.5	47.2xH23.6	31.5xH27.5	27.5xH27.5	47.2xH23.6	39.4xH27.5
TR	TR	TR	TR	TR	TR
110,00	171,00	110,00	107,00	171,00	147,00

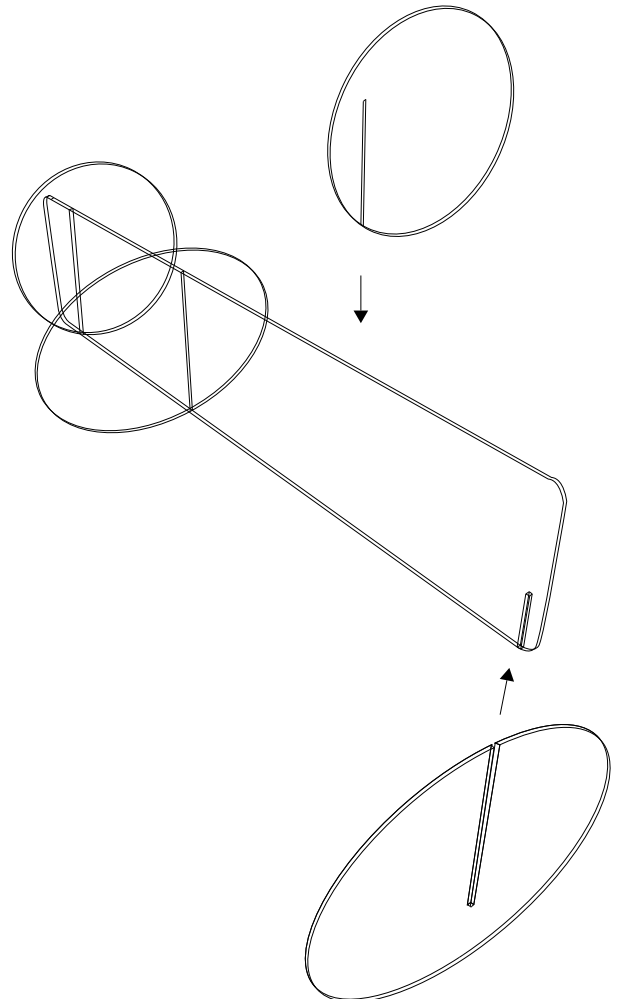
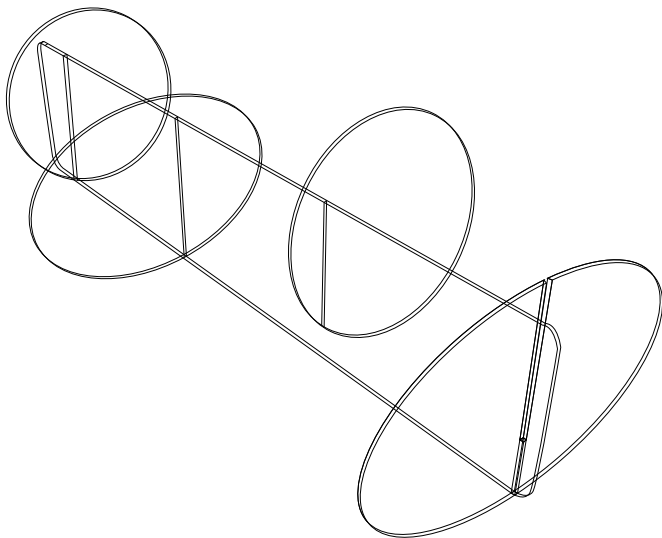



Spessore 1mm | thickness 1mm | epaisseur 1mm | Dicke 1mm | espesor 1mm
 Policarbonato | Polycarbonate

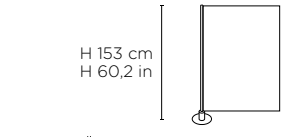

panel L 79cm / L 31.1in	Slalom	COD SL8P16	€ 271,00
	Slalom 1	COD S18P16	€ 223,00

panel L 99cm / L 31.1in	Slalom	COD SL10P16	€ 271,00
	Slalom 1	COD S110P16	€ 223,00

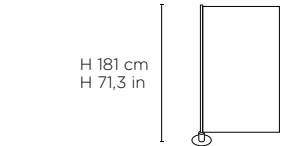

panel L 79cm / L 31.1in	Slalom	COD SL8P18	€ 278,00
	Slalom 1	COD S18P18	€ 230,00

panel L 99cm / L 31.1in	Slalom	COD SL10P18	€ 278,00
	Slalom 1	COD S110P18	€ 230,00

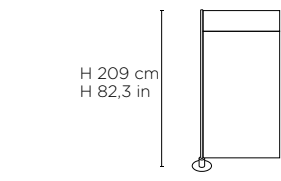

panel L 79cm / L 31.1in	Slalom	COD SL8P22	€ 315,00
panel L 99cm / L 31.1in	Slalom	COD SL10P22	€ 315,00

SL-M16	168,00	SL-M/M16	168,00
S1M16	120,00	S1M/M16	120,00

SL-M16	168,00	SL-M/M16	168,00
S1M16	120,00	S1M/M16	120,00

SL-M18	175,00	SL-M/M18	175,00
S1M18	127,00	S1M/M18	127,00

SL-M18	175,00	SL-M/M18	175,00
S1M18	127,00	S1M/M18	127,00

SL-M22	187,00	SL-M/M22	187,00
SL-M22	187,00	SL-M/M22	187,00

Nota: Pannello flessibile
Note: Flexible panel

0° - 360°

optional: i montanti nei colori fuori serie **NERO** (NG) e **BIANCO** (BO), sono soggetti ad un aumento del +15% sul prezzo di listino.
 I montanti nei colori **RAL** sono disponibili su richiesta.

optional: special upright colors **BLACK** (NG) and **WHITE** (BO), undergo an increase of +15% on the pricelist.
 The uprights in the **RAL** colours are available on request.

optional: les montants en couleurs **NOIR** (NG) et **BLANC** (BO), sont soumis à une augmentation de +15% sur le prix de liste.
 Les montants dans les couleurs **RAL** sont disponibles sur demande.

optional: Farbe **SCHWARZ** (NG) und **WEISS** (BO), verfügbar mit +15% auf Preisliste.
 Die Ständer in den **RAL**-Farben sind auf Anfrage erhältlich.

optional: colores por montantes **NEGRO** (NG) y **BLANCO** (BO), están sujetos a un incremento del +15% su precio de lista.
 Los montantes en los colores **RAL** están disponibles a petición.

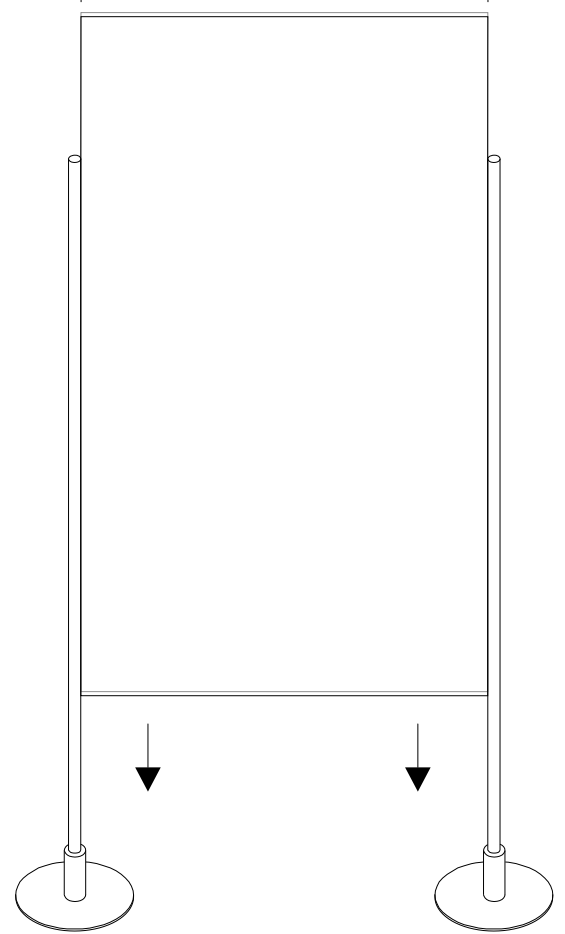

optional: + stampa digitale
optional: + digital print

<table border="1"> <tr> <td>COD</td> <td>SL-8/2P</td> <td>SL-10/2P</td> <td></td> </tr> <tr> <td>CM</td> <td>79xH27</td> <td>99xH27</td> <td></td> </tr> <tr> <td>IN</td> <td>31.1xH10.6</td> <td>39xH10.6</td> <td></td> </tr> <tr> <td>CO</td> <td>TR</td> <td>TR</td> <td></td> </tr> <tr> <td>€</td> <td>18,00</td> <td>18,00</td> <td>+38,00</td> </tr> </table>	COD	SL-8/2P	SL-10/2P		CM	79xH27	99xH27		IN	31.1xH10.6	39xH10.6		CO	TR	TR		€	18,00	18,00	+38,00	+		+38,00	+38,00
COD	SL-8/2P	SL-10/2P																						
CM	79xH27	99xH27																						
IN	31.1xH10.6	39xH10.6																						
CO	TR	TR																						
€	18,00	18,00	+38,00																					
<table border="1"> <tr> <td>COD</td> <td>SL-8/16P</td> <td>SL-10/16P</td> <td></td> </tr> <tr> <td>CM</td> <td>79xH138</td> <td>99xH138</td> <td></td> </tr> <tr> <td>IN</td> <td>31.1xH54.3</td> <td>39xH54.3</td> <td></td> </tr> <tr> <td>CO</td> <td>TR</td> <td>TR</td> <td></td> </tr> <tr> <td>€</td> <td>103,00</td> <td>103,00</td> <td>+118,00</td> </tr> </table>	COD	SL-8/16P	SL-10/16P		CM	79xH138	99xH138		IN	31.1xH54.3	39xH54.3		CO	TR	TR		€	103,00	103,00	+118,00	+		+118,00	+118,00
COD	SL-8/16P	SL-10/16P																						
CM	79xH138	99xH138																						
IN	31.1xH54.3	39xH54.3																						
CO	TR	TR																						
€	103,00	103,00	+118,00																					
<table border="1"> <tr> <td>COD</td> <td>SL-8/18P</td> <td>SL-10/18P</td> <td></td> </tr> <tr> <td>CM</td> <td>79xH167</td> <td>99xH167</td> <td></td> </tr> <tr> <td>IN</td> <td>31.1xH65.8</td> <td>39xH65.8</td> <td></td> </tr> <tr> <td>CO</td> <td>TR</td> <td>TR</td> <td></td> </tr> <tr> <td>€</td> <td>103,00</td> <td>103,00</td> <td>+136,00</td> </tr> </table>	COD	SL-8/18P	SL-10/18P		CM	79xH167	99xH167		IN	31.1xH65.8	39xH65.8		CO	TR	TR		€	103,00	103,00	+136,00	+		+136,00	+136,00
COD	SL-8/18P	SL-10/18P																						
CM	79xH167	99xH167																						
IN	31.1xH65.8	39xH65.8																						
CO	TR	TR																						
€	103,00	103,00	+136,00																					

Slalom/Slalom1

Ø 32 cm
 Ø 12,6 in

COD	xxxxxx/32	+	xxxxxx/32	xxxxxx/32
€	xxx,xxx + € 20,00	+	xxx,xxx + € 20,00	xxx,xxx + € 20,00



Spessore 4mm | thickness 4mm | epaisseur 4mm | Dicke 4mm | espesor 4mm
Acrilico rigido | Rigid Acrylic

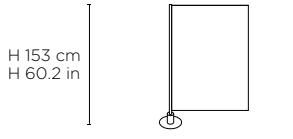

COD	SL10ES2/1
CO	TR
€	345,00

COD	SL10ES2/1/32
CO	TR
€	365,00

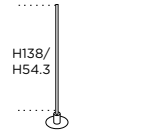

COD	SL-M16/5
AG	
€	168,00

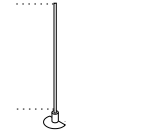

COD	SL-M/M16/5
AG	
€	168,00

+

COD	SL-M16/5/32
AG	
€	188,00

COD	SL-M/M16/5/32
AG	
€	188,00

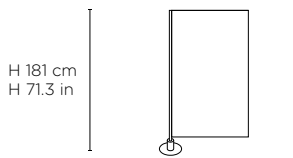

COD	SL10ES3
CO	TR
€	379,00

COD	SL10ES3/32
CO	TR
€	399,00

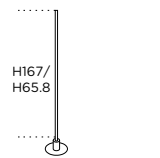

COD	SL-M18/5
AG	
€	175,00

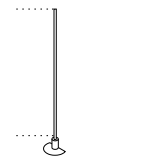

COD	SL-M/M18/5
AG	
€	175,00

+

COD	SL-M18/5/32
AG	
€	195,00

COD	SL-M/M18/5/32
AG	
€	195,00

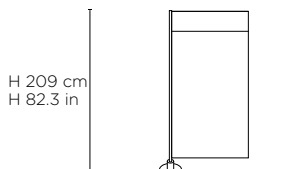

COD	SL10ES3/1
CO	CAT A
€	on request

COD	SL10ES3/1/32
CO	CAT A
€	on request

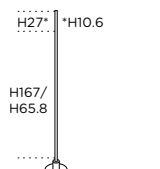

COD	SL-M22/5
AG	
€	187,00

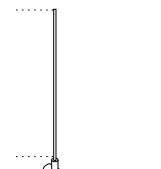

COD	SL-M/M22/5
AG	
€	187,00

+

COD	SL-M22/5/32
AG	
€	207,00

COD	SL-M/M22/5/32
AG	
€	207,00

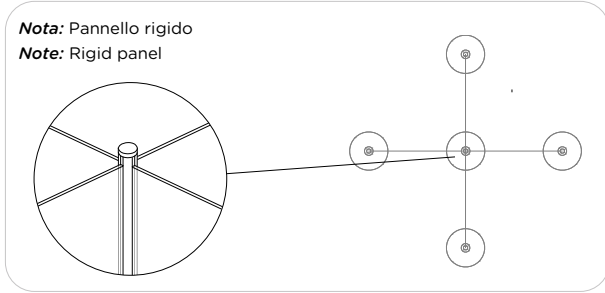

optional: i montanti nei colori fuori serie **NERO** (NG) e **BIANCO** (BO), sono soggetti ad un aumento del +15% sul prezzo di listino.
I montanti nei colori **RAL** sono disponibili su richiesta.
optional: special upright colors **BLACK** (NG) and **WHITE** (BO), undergo an increase of +15% on the pricelist.
The uprights in the **RAL** colours are available on request.
optional: les montants en couleurs **NOIR** (NG) et **BLANC** (BO), sont soumis à une augmentation de +15% sur le prix de liste.
Les montants dans les couleurs **RAL** sont disponibles sur demande.
optional: Farbe **SCHWARZ** (NG) und **WEISS** (BO), verfügbar mit +15% auf Preisliste.
Die Ständer in den **RAL**-Farben sind auf Anfrage erhältlich.
optional: colores por montantes **NEGRO** (NG) y **BLANCO** (BO), están sujetos a un incremento del +15% su precio de lista.
Los montantes en los colores **RAL** están disponibles a petición.

optional: + stampa digitale
optional: + digital print

<input type="checkbox"/>	COD	SL-8/2P	SL-10/2P		
	CM	79xH27	99xH27		
	IN	31.1xH10.6	39xH10.6		
	CO	TR	TR		
	€	on request	on request	+	+38,00 +38,00
<input type="checkbox"/>	COD	SL-8/16P	SL-10/16P		
	CM	79xH138	99xH138		
	IN	31.1xH54.3	39xH54.3		
	CO	TR	TR		
	€	177,00	177,00	+	+118,00 +118,00
<input type="checkbox"/>	COD	SL-8/18P	SL-10/18P		
	CM	79xH167	99xH167		
	IN	31.1xH65.8	39xH65.8		
	CO	TR	TR		
	€	204,00	204,00	+	+136,00 +136,00

